

PAROC Marine Slab 40, HP60 - HP240

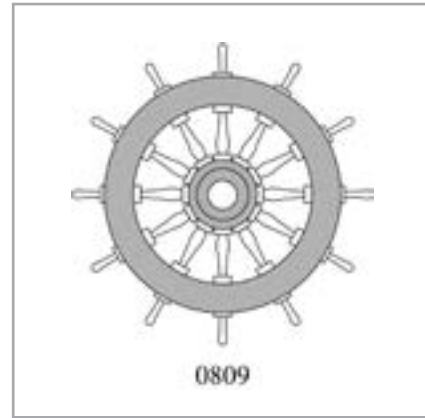
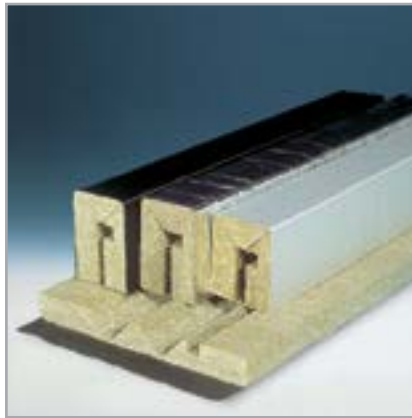

Example of order:

PAROC Marine Slab 40 G1, HP160 S1

Product name _____

Select the facing from table 1 _____

Select the product size from figure 1 _____

Select the position of the facing from table 2* _____

* Please note! AluCoat® and LF1 facings only with standard positioning.

Table 1. Facings

Facing	Description
AluCoat®	Reinforced aluminium foil
G1	White glass fibre cloth, ~ 210 g/m ²
G2	Black glass fibre cloth, ~ 200 g/m ²
G3	White glass fibre cloth, ~ 430 g/m ²
G4	White glass fibre cloth + aluminium foil, ~ 250 g/m ² (cloth on top)
G7	White glass fibre cloth + aluminium foil, ~ 250 g/m ² (foil on top)
LF1	Lacquered aluminium laminate with grey glass fibre reinforcement, ~ 97 g/m ²

Table 2. Position of the G-facings

Code	Description
-	Standard, no overlapping.
S1	Overlapping ~30 mm
S2	Overlapping ~30 mm
S3	Overlapping ~30 mm
S4	Overlapping ~30 mm
S5	Overlapping ~30 mm
S6	Overlapping ~30 mm
S7	Overlapping ~30 mm
S8	Overlapping ~30 mm
S9	Overlapping ~30 mm

Technical Insulation

Marine ins./Product information

2 - 6.32

September 2013

Replaces: March 2008

Figure 1. Sizes

Dimensions, mm (length of insulation 900 or 1200 mm) HP60 - HP180

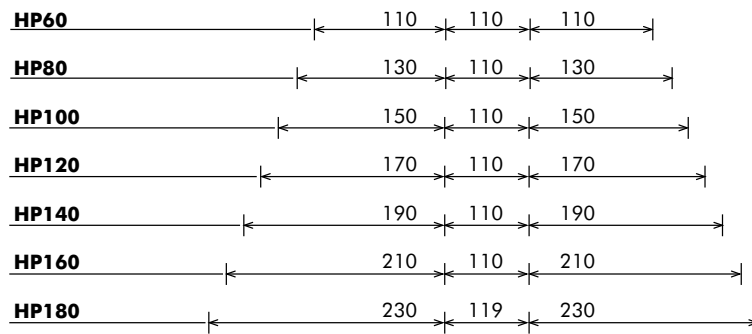
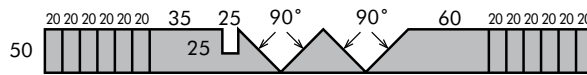
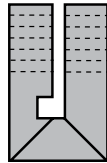

Dimensions, mm (length of insulation 900 or 1200 mm) HP200 - HP240

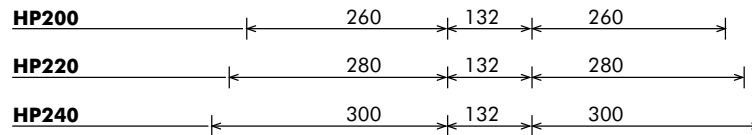
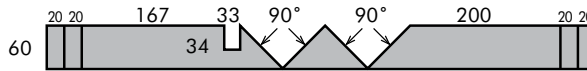
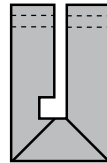

PAROC Marine Slab 40, HP260 - HP400

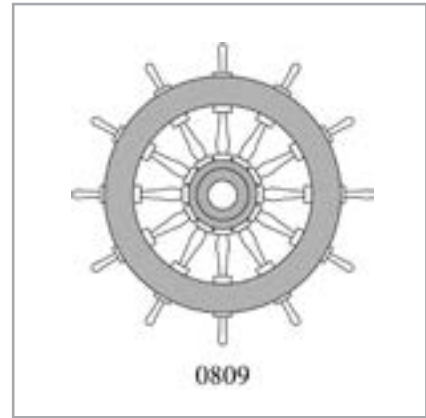
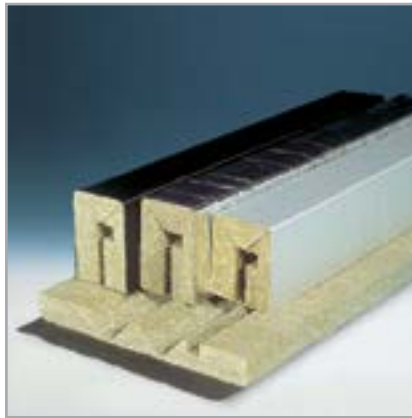

Example of order:

PAROC Marine Slab 40 G1, HP260 S1

Product name _____

Select the facing from table 1 _____

Select the product size from figure 1 _____











Select the position of the facing from table 2* _____

* Please note! AluCoat® and LF1 facings only with standard positioning.

Table 1. Facings

Facing	Description
AluCoat®	Reinforced aluminium foil
G1	White glass fibre cloth, ~ 210 g/m ²
G2	Black glass fibre cloth, ~ 200 g/m ²
G3	White glass fibre cloth, ~ 430 g/m ²
G4	White glass fibre cloth + aluminium foil, ~ 250 g/m ² (cloth on top)
G7	White glass fibre cloth + aluminium foil, ~ 250 g/m ² (foil on top)
LF1	Lacquered aluminium laminate with grey glass fibre reinforcement, ~ 97 g/m ²

Table 2. Position of the G-facings

Code	Description
-	Standard, no overlapping. 
S1	Overlapping ~30 mm 
S2	Overlapping ~30 mm 
S3	Overlapping ~30 mm 
S4	Overlapping ~30 mm 
S5	Overlapping ~30 mm 
S6	Overlapping ~30 mm 
S7	Overlapping ~30 mm 
S8	Overlapping ~30 mm 
S9	Overlapping ~30 mm 

Technical Insulation

Marine ins./Product information

2 - 6.33

September 2013

Replaces: March 2008

Figure 1. Sizes

Dimensions, mm (length of insulation is 900 or 1200 mm) HP260 - HP300

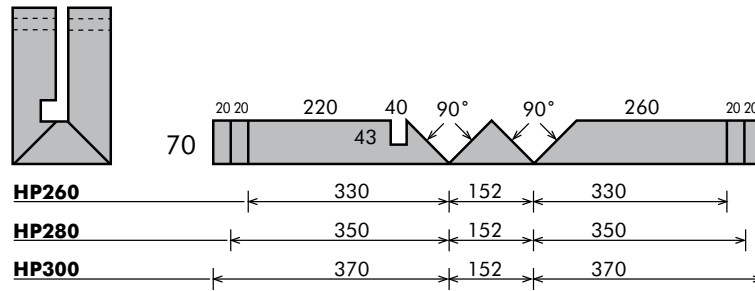

Dimensions, mm (length of insulation is 900 or 1200 mm) HP320, HP340

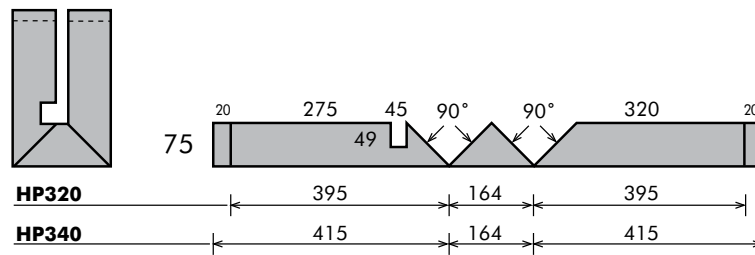

Dimensions, mm (length of insulation is 900 or 1200 mm) HP400

